

## FGH30N6S2D / FGP30N6S2D / FGB30N6S2D

### 600V, SMPS II Series N-Channel IGBT with Anti-Parallel Stealth™ Diode

#### General Description

The FGH30N6S2D, FGP30N6S2D, and FGB30N6S2D are Low Gate Charge, Low Plateau Voltage SMPS II IGBTs combining the fast switching speed of the SMPS IGBTs along with lower gate charge and plateau voltage and avalanche capability (UIS). These LGC devices shorten delay times, and reduce the power requirement of the gate drive. These devices are ideally suited for high voltage switched mode power supply applications where low conduction loss, fast switching times and UIS capability are essential. SMPS II LGC devices have been specially designed for:

- Power Factor Correction (PFC) circuits
- Full bridge topologies
- Half bridge topologies
- Push-Pull circuits
- Uninterruptible power supplies
- Zero voltage and zero current switching circuits

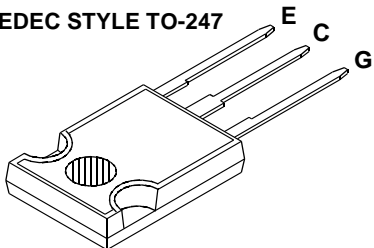
#### Features

- 100kHz Operation at 390V, 14A
- 200kHz Operation at 390V, 9A
- 600V Switching SOA Capability
- Typical Fall Time. . . . . 90ns at  $T_J = 125^\circ\text{C}$
- Low Gate Charge . . . . . 23nC at  $V_{GE} = 15\text{V}$
- Low Plateau Voltage . . . . . 6.5V Typical
- UIS Rated . . . . . 150mJ
- Low Conduction Loss

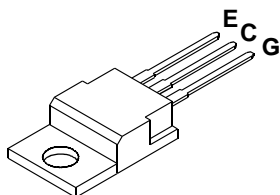
IGBT formerly Developmental Type TA49336  
Diode formerly Developmental Type TA49390

#### Package

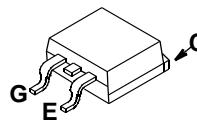
JEDEC STYLE TO-247



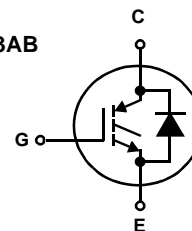
JEDEC STYLE TO-220AB



JEDEC STYLE TO-263AB



#### Symbol



#### Device Maximum Ratings $T_C = 25^\circ\text{C}$ unless otherwise noted

Symbol	Parameter	Ratings	Units
$BV_{CES}$	Collector to Emitter Breakdown Voltage	600	V
$I_{C25}$	Collector Current Continuous, $T_C = 25^\circ\text{C}$	45	A
$I_{C110}$	Collector Current Continuous, $T_C = 110^\circ\text{C}$	20	A
$I_{CM}$	Collector Current Pulsed (Note 1)	108	A
$V_{GES}$	Gate to Emitter Voltage Continuous	$\pm 20$	V
$V_{GEM}$	Gate to Emitter Voltage Pulsed	$\pm 30$	V
SSOA	Switching Safe Operating Area at $T_J = 150^\circ\text{C}$ , Figure 2	60A at 600V	
$E_{AS}$	Pulsed Avalanche Energy, $I_{CE} = 12\text{A}$ , $L = 2\text{mH}$ , $V_{DD} = 50\text{V}$	150	mJ
$P_D$	Power Dissipation Total $T_C = 25^\circ\text{C}$	167	W
	Power Dissipation Derating $T_C > 25^\circ\text{C}$	1.33	W/ $^\circ\text{C}$
$T_J$	Operating Junction Temperature Range	-55 to 150	$^\circ\text{C}$
$T_{STG}$	Storage Junction Temperature Range	-55 to 150	$^\circ\text{C}$

**CAUTION:** Stresses above those listed in "Absolute Maximum Ratings" may cause permanent damage to the device. This is a stress only rating and operation of the device at these or any other conditions above those indicated in the operational sections of this specification is not implied.

**NOTE:**

1. Pulse width limited by maximum junction temperature.

## Package Marking and Ordering Information

Device Marking	Device	Package	Tape Width	Quantity
30N6S2D	FGB30N6S2D	TO-263AB	24mm	800
30N6S2D	FGP30N6S2D	TO-220AB	-	-
30N6S2D	FGH30N6S2D	TO-247	-	-

## Electrical Characteristics $T_J = 25^\circ\text{C}$ unless otherwise noted

Symbol	Parameter	Test Conditions	Min	Typ	Max	Units
--------	-----------	-----------------	-----	-----	-----	-------

### Off State Characteristics

$BV_{CES}$	Collector to Emitter Breakdown Voltage	$I_C = 250\mu\text{A}$ , $V_{GE} = 0$	600	-	-	V	
$I_{CES}$	Collector to Emitter Leakage Current	$V_{CE} = 600\text{V}$	$T_J = 25^\circ\text{C}$	-	-	250	$\mu\text{A}$
			$T_J = 125^\circ\text{C}$	-	-	2	mA
$I_{GES}$	Gate to Emitter Leakage Current	$V_{GE} = \pm 20\text{V}$	-	-	$\pm 250$	nA	

### On State Characteristics

$V_{CE(SAT)}$	Collector to Emitter Saturation Voltage	$I_C = 12\text{A}$ , $V_{GE} = 15\text{V}$	$T_J = 25^\circ\text{C}$	-	1.95	2.5	V
			$T_J = 125^\circ\text{C}$	-	1.8	2.0	V
$V_{EC}$	Diode Forward Voltage	$I_{EC} = 12\text{A}$		-	2.1	2.5	V

### Dynamic Characteristics

$Q_{G(ON)}$	Gate Charge	$I_C = 12\text{A}$ , $V_{CE} = 300\text{V}$	$V_{GE} = 15\text{V}$	-	23	29	nC
			$V_{GE} = 20\text{V}$	-	26	33	nC
$V_{GE(TH)}$	Gate to Emitter Threshold Voltage	$I_C = 250\mu\text{A}$ , $V_{CE} = 600\text{V}$		3.5	4.3	5.0	V
$V_{GEP}$	Gate to Emitter Plateau Voltage	$I_C = 12\text{A}$ , $V_{CE} = 300\text{V}$		-	6.5	8.0	V

### Switching Characteristics

SSOA	Switching SOA	$T_J = 150^\circ\text{C}$ , $R_G = 10\Omega$ , $V_{GE} = 15\text{V}$ , $L = 100\mu\text{H}$ , $V_{CE} = 600\text{V}$		60	-	-	A
$t_{d(ON)I}$	Current Turn-On Delay Time	IGBT and Diode at $T_J = 25^\circ\text{C}$ ,		-	6	-	ns
$t_{rI}$	Current Rise Time	$I_{CE} = 12\text{A}$ ,		-	10	-	ns
$t_{d(OFF)I}$	Current Turn-Off Delay Time	$V_{CE} = 390\text{V}$ ,		-	40	-	ns
$t_{fI}$	Current Fall Time	$V_{GE} = 15\text{V}$ ,		-	53	-	ns
$E_{ON1}$	Turn-On Energy (Note 2)	$R_G = 10\Omega$		-	55	-	$\mu\text{J}$
$E_{ON2}$	Turn-On Energy (Note 2)	$L = 500\mu\text{H}$		-	110	-	$\mu\text{J}$
$E_{OFF}$	Turn-Off Energy (Note 3)	Test Circuit - Figure 26		-	100	150	$\mu\text{J}$
$t_{d(ON)I}$	Current Turn-On Delay Time	IGBT and Diode at $T_J = 125^\circ\text{C}$		-	11	-	ns
$t_{rI}$	Current Rise Time	$I_{CE} = 12\text{A}$ ,		-	17	-	ns
$t_{d(OFF)I}$	Current Turn-Off Delay Time	$V_{CE} = 390\text{V}$ ,		-	73	100	ns
$t_{fI}$	Current Fall Time	$V_{GE} = 15\text{V}$ ,		-	90	100	ns
$E_{ON1}$	Turn-On Energy (Note 2)	$R_G = 10\Omega$		-	55	-	$\mu\text{J}$
$E_{ON2}$	Turn-On Energy (Note 2)	$L = 500\mu\text{H}$		-	160	200	$\mu\text{J}$
$E_{OFF}$	Turn-Off Energy (Note 3)	Test Circuit - Figure 26		-	250	350	$\mu\text{J}$
$t_{rr}$	Diode Reverse Recovery Time	$I_{EC} = 12\text{A}$ , $di_{EC}/dt = 200\text{A}/\mu\text{s}$		-	35	46	ns
		$I_{EC} = 1\text{A}$ , $di_{EC}/dt = 200\text{A}/\mu\text{s}$		-	25	32	ns

### Thermal Characteristics

$R_{\theta JC}$	Thermal Resistance Junction-Case	IGBT	-	-	0.75	$^\circ\text{C}/\text{W}$
		Diode	-	-	2.0	$^\circ\text{C}/\text{W}$

NOTE:

2. Values for two Turn-On loss conditions are shown for the convenience of the circuit designer.  $E_{ON1}$  is the turn-on loss of the IGBT only.  $E_{ON2}$  is the turn-on loss when a typical diode is used in the test circuit and the diode is at the same  $T_J$  as the IGBT. The diode type is specified in figure 26.

3. Turn-Off Energy Loss ( $E_{OFF}$ ) is defined as the integral of the instantaneous power loss starting at the trailing edge of the input pulse and ending at the point where the collector current equals zero ( $I_{CE} = 0\text{A}$ ). All devices were tested per JEDEC Standard No. 24-1 Method for Measurement of Power Device Turn-Off Switching Loss. This test method produces the true total Turn-Off Energy Loss.

## Typical Performance Curves

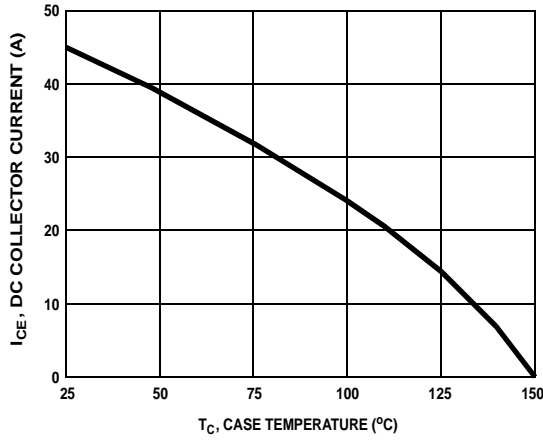


Figure 1. DC Collector Current vs Case Temperature

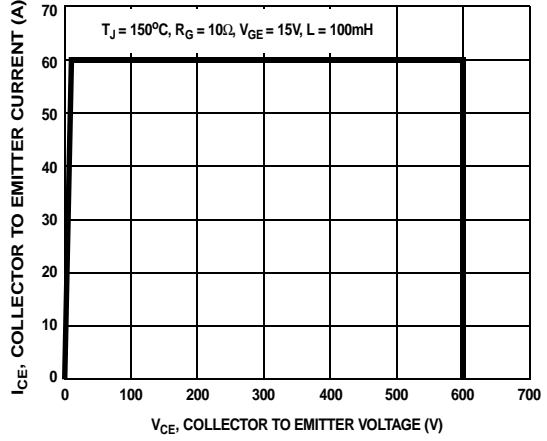


Figure 2. Minimum Switching Safe Operating Area

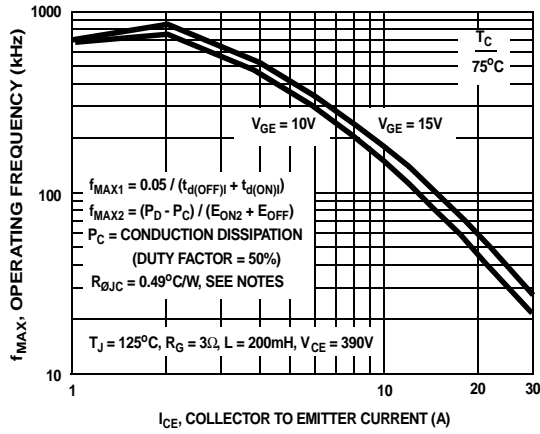


Figure 3. Operating Frequency vs Collector to Emitter Current

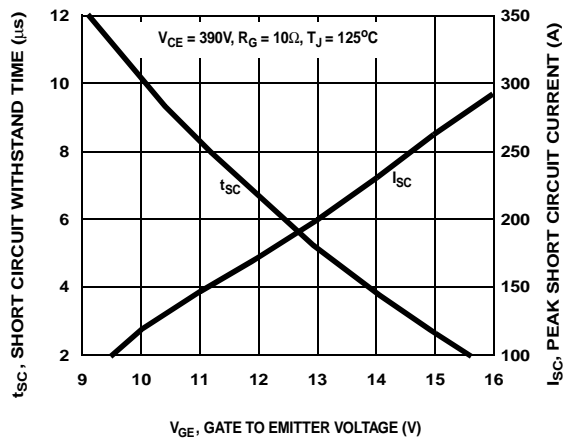


Figure 4. Short Circuit Withstand Time

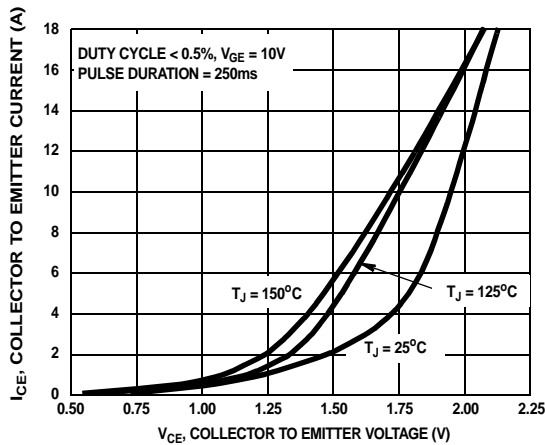


Figure 5. Collector to Emitter On-State Voltage

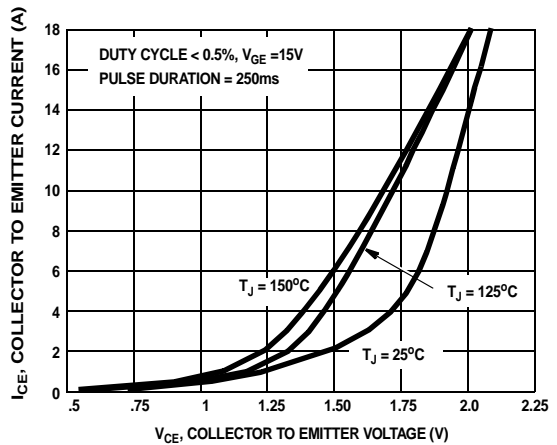
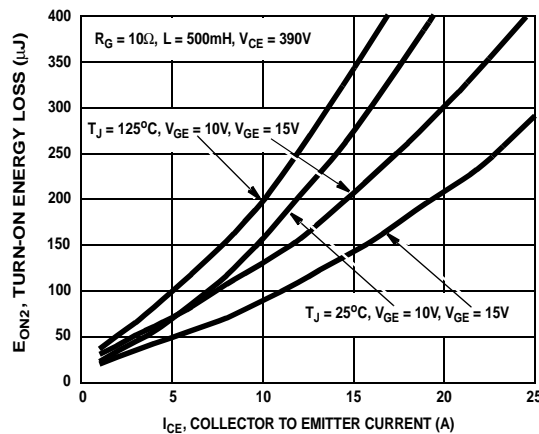
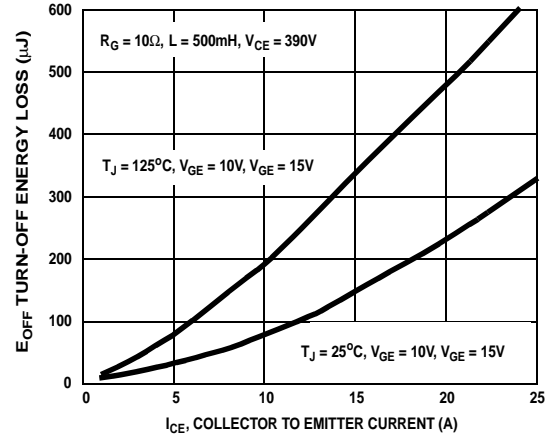


Figure 6. Collector to Emitter On-State Voltage

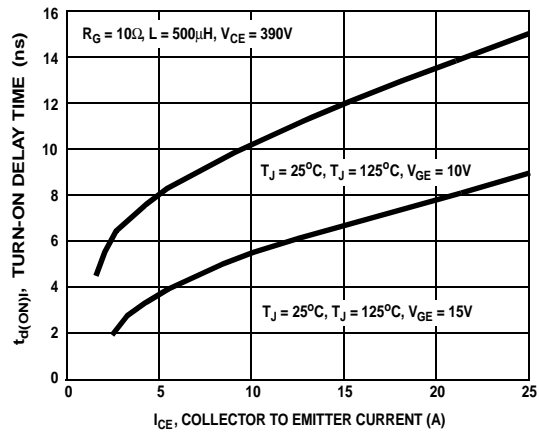
**Typical Performance Curves** (Continued)



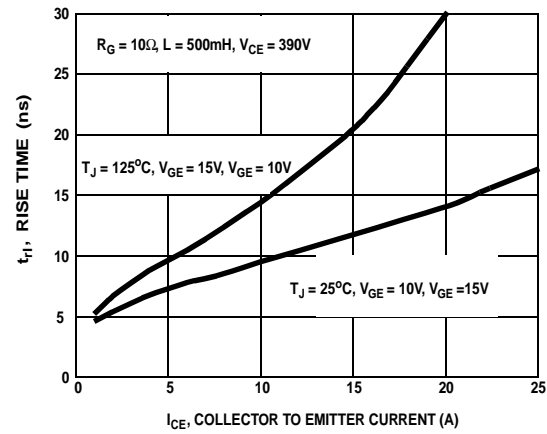
**Figure 7. Turn-On Energy Loss vs Collector to Emitter Current**



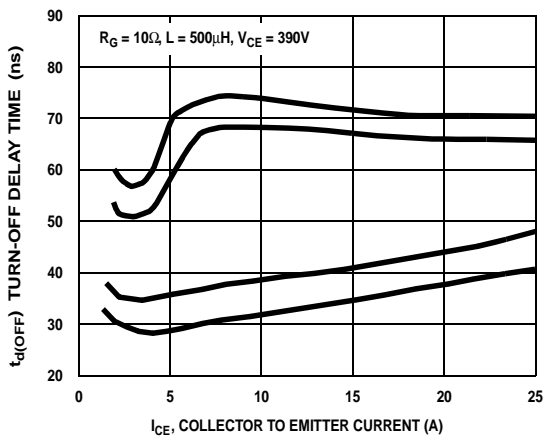
**Figure 8. Turn-Off Energy Loss vs Collector to Emitter Current**



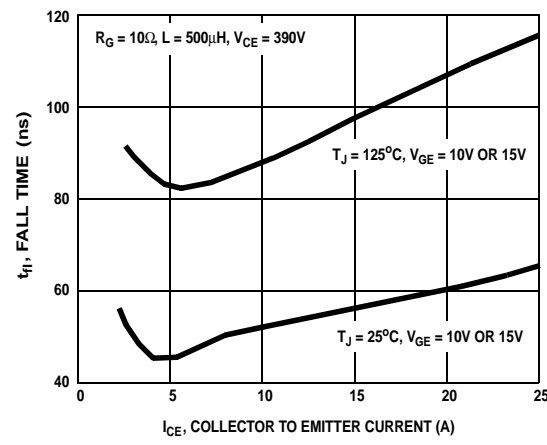
**Figure 9. Turn-On Delay Time vs Collector to Emitter Current**



**Figure 10. Turn-On Rise Time vs Collector to Emitter Current**

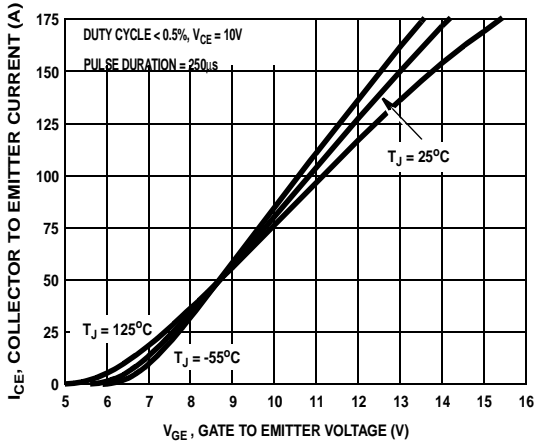


**Figure 11. Turn-Off Delay Time vs Collector to Emitter Current**

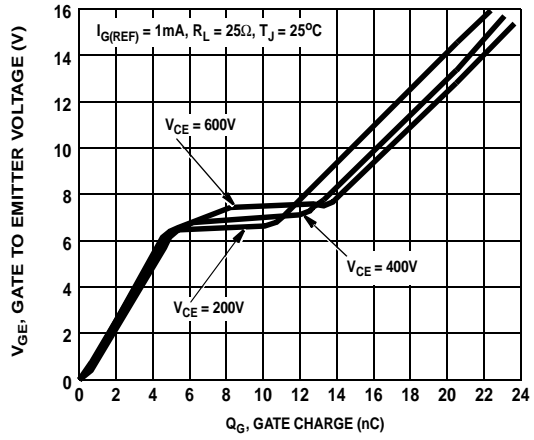


**Figure 12. Fall Time vs Collector to Emitter Current**

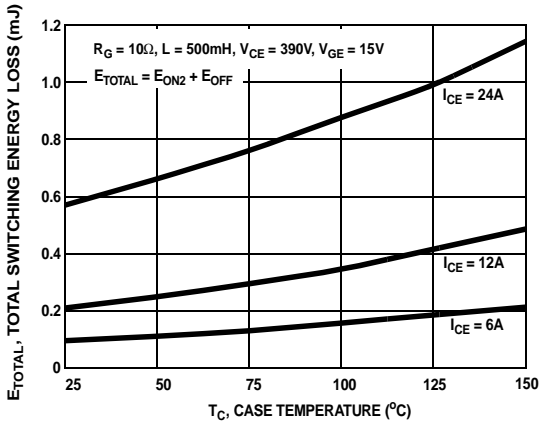
**Typical Performance Curves (Continued)**



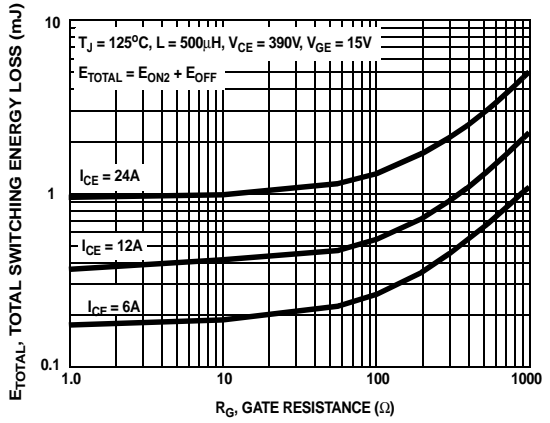
**Figure 13. Transfer Characteristic**



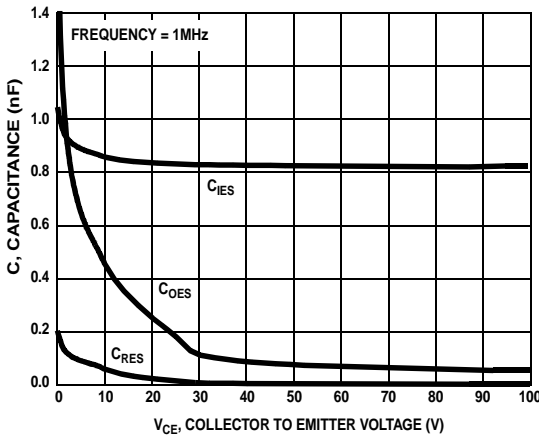
**Figure 14. Gate Charge**



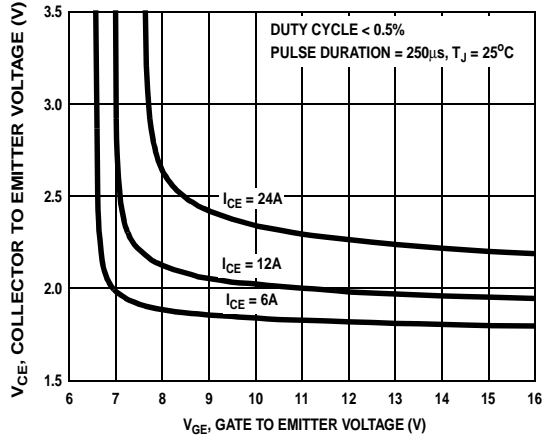
**Figure 15. Total Switching Loss vs Case Temperature**



**Figure 16. Total Switching Loss vs Gate Resistance**

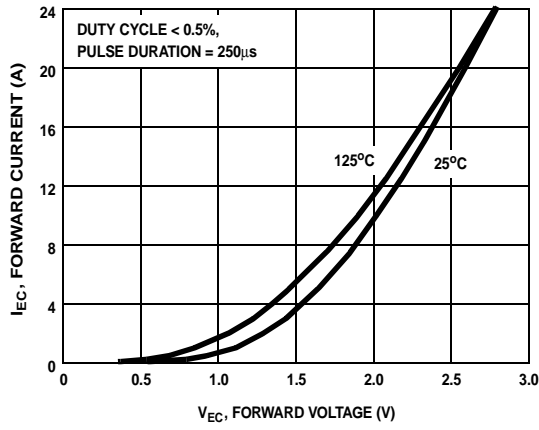


**Figure 17. Capacitance vs Collector to Emitter Voltage**

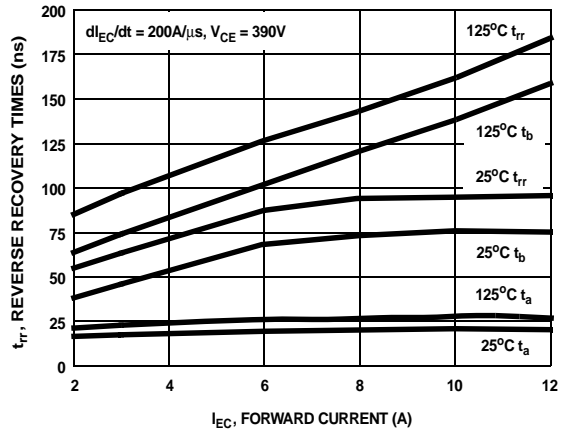


**Figure 18. Collector to Emitter On-State Voltage vs Gate to Emitter Voltage**

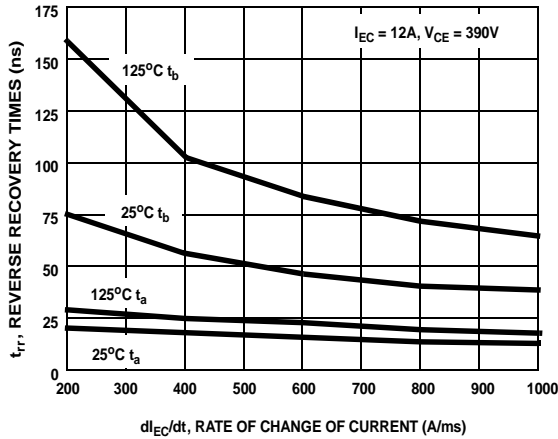
**Typical Performance Curves** (Continued)



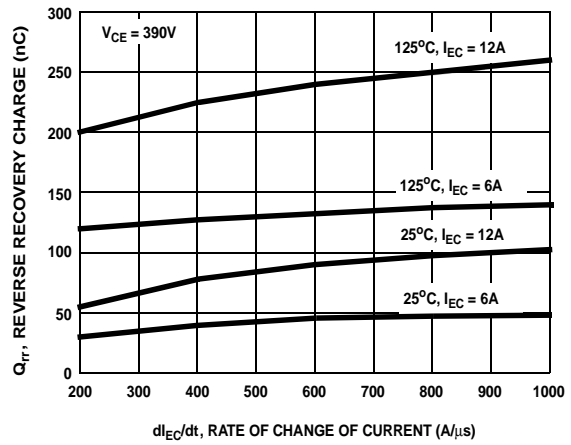
**Figure 19. Diode Forward Current vs Forward Voltage Drop**



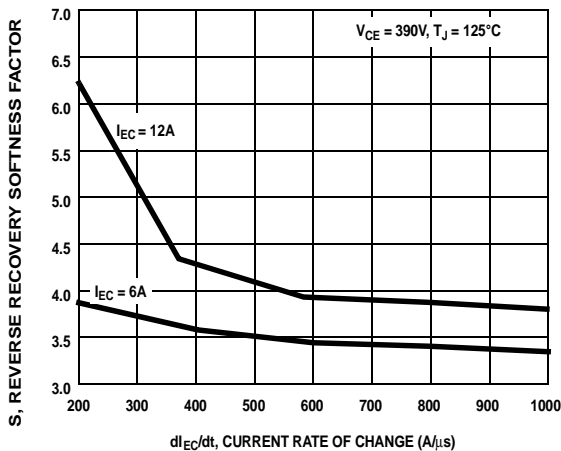
**Figure 20. Recovery Times vs Forward Current**



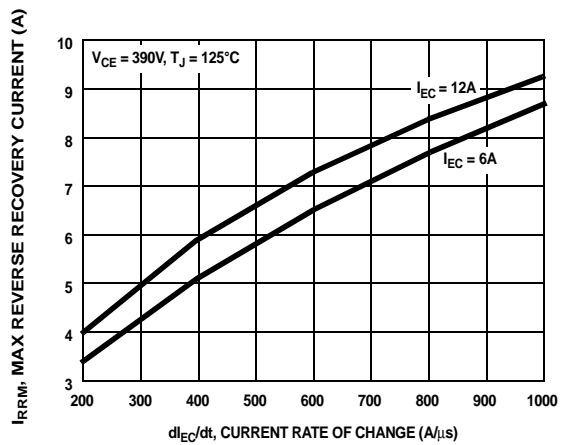
**Figure 21. Recovery Times vs Rate of Change of Current**



**Figure 22. Stored Charge vs Rate of Change of Current**

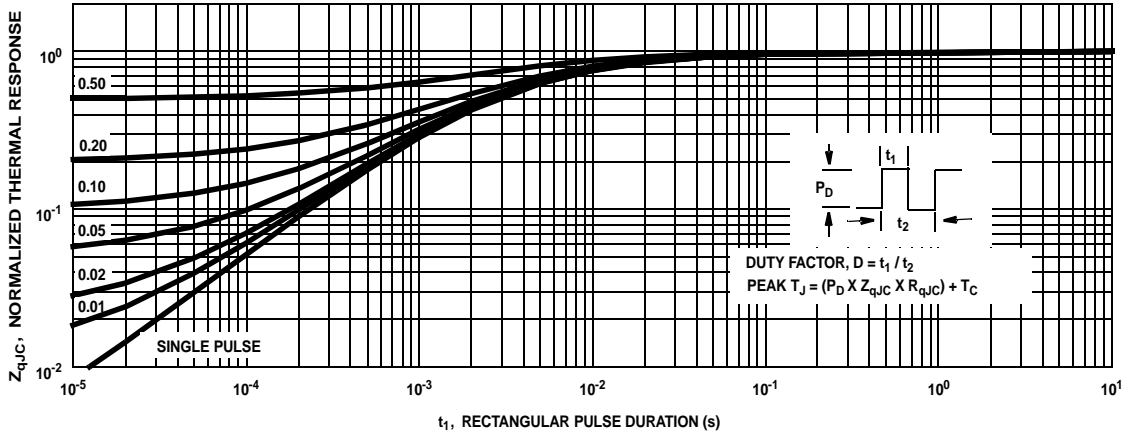


**Figure 23. Reverse Recovery Softness Factor vs Rate of Change of Current**



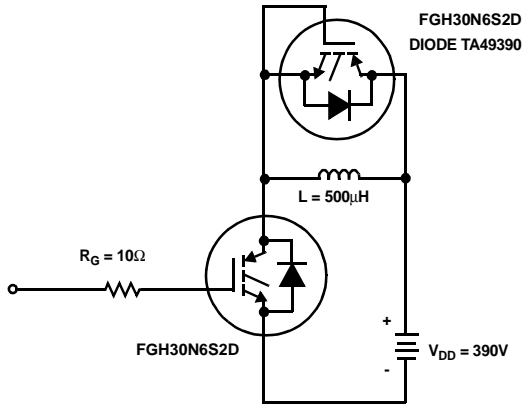
**Figure 24. Maximum Reverse Recovery Current vs Rate of Change of Current**

**Typical Performance Curves** (Continued)

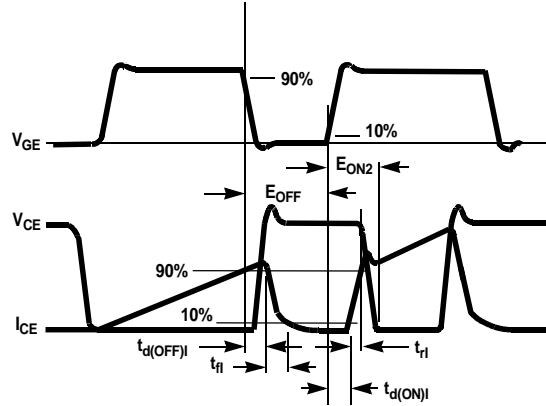


**Figure 25. IGBT Normalized Transient Thermal Impedance, Junction to Case**

**Test Circuit and Waveforms**



**Figure 26. Inductive Switching Test Circuit**



**Figure 27. Switching Test Waveforms**

## Handling Precautions for IGBTs

Insulated Gate Bipolar Transistors are susceptible to gate-insulation damage by the electrostatic discharge of energy through the devices. When handling these devices, care should be exercised to assure that the static charge built in the handler's body capacitance is not discharged through the device. With proper handling and application procedures, however, IGBTs are currently being extensively used in production by numerous equipment manufacturers in military, industrial and consumer applications, with virtually no damage problems due to electrostatic discharge. IGBTs can be handled safely if the following basic precautions are taken:

1. Prior to assembly into a circuit, all leads should be kept shorted together either by the use of metal shorting springs or by the insertion into conductive material such as "ECCOSORBD™ LD26" or equivalent.
2. When devices are removed by hand from their carriers, the hand being used should be grounded by any suitable means - for example, with a metallic wristband.
3. Tips of soldering irons should be grounded.
4. Devices should never be inserted into or removed from circuits with power on.
5. **Gate Voltage Rating** - Never exceed the gate-voltage rating of  $V_{GEM}$ . Exceeding the rated  $V_{GE}$  can result in permanent damage to the oxide layer in the gate region.
6. **Gate Termination** - The gates of these devices are essentially capacitors. Circuits that leave the gate open-circuited or floating should be avoided. These conditions can result in turn-on of the device due to voltage buildup on the input capacitor due to leakage currents or pickup.
7. **Gate Protection** - These devices do not have an internal monolithic Zener diode from gate to emitter. If gate protection is required an external Zener is recommended.

## Operating Frequency Information

Operating frequency information for a typical device (Figure 3) is presented as a guide for estimating device performance for a specific application. Other typical frequency vs collector current ( $I_{CE}$ ) plots are possible using the information shown for a typical unit in Figures 5, 6, 7, 8, 9 and 11. The operating frequency plot (Figure 3) of a typical device shows  $f_{MAX1}$  or  $f_{MAX2}$ ; whichever is smaller at each point. The information is based on measurements of a typical device and is bounded by the maximum rated junction temperature.

$f_{MAX1}$  is defined by  $f_{MAX1} = 0.05 / (t_{d(OFF)1} + t_{d(ON)1})$ . Deadtime (the denominator) has been arbitrarily held to 10% of the on-state time for a 50% duty factor. Other definitions are possible.  $t_{d(OFF)1}$  and  $t_{d(ON)1}$  are defined in Figure 27. Device turn-off delay can establish an additional frequency limiting condition for an application other than  $T_{JM}$ .  $t_{d(OFF)1}$  is important when controlling output ripple under a lightly loaded condition.

$f_{MAX2}$  is defined by  $f_{MAX2} = (P_D - P_C) / (E_{OFF} + E_{ON2})$ . The allowable dissipation ( $P_D$ ) is defined by  $P_D = (T_{JM} - T_C) / R_{\theta JC}$ . The sum of device switching and conduction losses must not exceed  $P_D$ . A 50% duty factor was used (Figure 3) and the conduction losses ( $P_C$ ) are approximated by  $P_C = (V_{CE} \times I_{CE}) / 2$ .

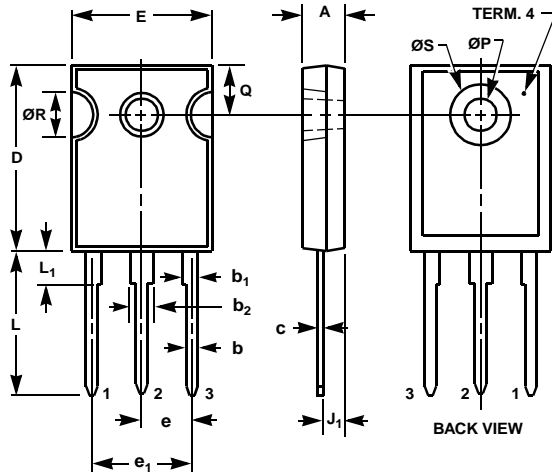
$E_{ON2}$  and  $E_{OFF}$  are defined in the switching waveforms shown in Figure 27.  $E_{ON2}$  is the integral of the instantaneous power loss ( $I_{CE} \times V_{CE}$ ) during turn-on and  $E_{OFF}$  is the integral of the instantaneous power loss ( $I_{CE} \times V_{CE}$ ) during turn-off. All tail losses are included in the calculation for  $E_{OFF}$ ; i.e., the collector current equals zero ( $I_{CE} = 0$ )

ECCOSORBD™ is a Trademark of Emerson and Cumming, Inc.



# TO-247

## 3 LEAD JEDEC STYLE TO-247 PLASTIC PACKAGE



SYMBOL	INCHES		MILLIMETERS		NOTES
	MIN	MAX	MIN	MAX	
A	0.180	0.190	4.58	4.82	-
b	0.046	0.051	1.17	1.29	2, 3
b <sub>1</sub>	0.060	0.070	1.53	1.77	1, 2
b <sub>2</sub>	0.095	0.105	2.42	2.66	1, 2
c	0.020	0.026	0.51	0.66	1, 2, 3
D	0.800	0.820	20.32	20.82	-
E	0.605	0.625	15.37	15.87	-
e	0.219 TYP		5.56 TYP		4
e <sub>1</sub>	0.438 BSC		11.12 BSC		4
J <sub>1</sub>	0.090	0.105	2.29	2.66	5
L	0.620	0.640	15.75	16.25	-
L <sub>1</sub>	0.145	0.155	3.69	3.93	1
ØP	0.138	0.144	3.51	3.65	-
Q	0.210	0.220	5.34	5.58	-
ØR	0.195	0.205	4.96	5.20	-
ØS	0.260	0.270	6.61	6.85	-

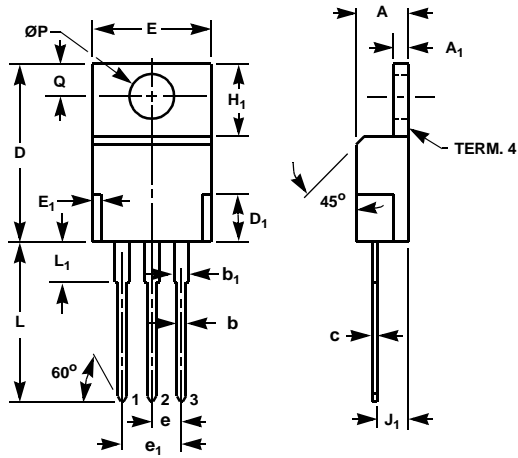
### NOTES:

1. Lead dimension and finish uncontrolled in L<sub>1</sub>.
2. Lead dimension (without solder).
3. Add typically 0.002 inches (0.05mm) for solder coating.
4. Position of lead to be measured 0.250 inches (6.35mm) from bottom of dimension D.
5. Position of lead to be measured 0.100 inches (2.54mm) from bottom of dimension D.
6. Controlling dimension: Inch.
7. Revision 1 dated 1-93.

FGH30N6S2D / FGP30N6S2D / FGB30N6S2D

# TO-220AB

## 3 LEAD JEDEC TO-220AB PLASTIC PACKAGE



SYMBOL	INCHES		MILLIMETERS		NOTES
	MIN	MAX	MIN	MAX	
A	0.170	0.180	4.32	4.57	-
A <sub>1</sub>	0.048	0.052	1.22	1.32	-
b	0.030	0.034	0.77	0.86	3, 4
b <sub>1</sub>	0.045	0.055	1.15	1.39	2, 3
c	0.014	0.019	0.36	0.48	2, 3, 4
D	0.590	0.610	14.99	15.49	-
D <sub>1</sub>	-	0.160	-	4.06	-
E	0.395	0.410	10.04	10.41	-
E <sub>1</sub>	-	0.030	-	0.76	-
e	0.100 TYP		2.54 TYP		5
e <sub>1</sub>	0.200 BSC		5.08 BSC		5
H <sub>1</sub>	0.235	0.255	5.97	6.47	-
J <sub>1</sub>	0.100	0.110	2.54	2.79	6
L	0.530	0.550	13.47	13.97	-
L <sub>1</sub>	0.130	0.150	3.31	3.81	2
ØP	0.149	0.153	3.79	3.88	-
Q	0.102	0.112	2.60	2.84	-

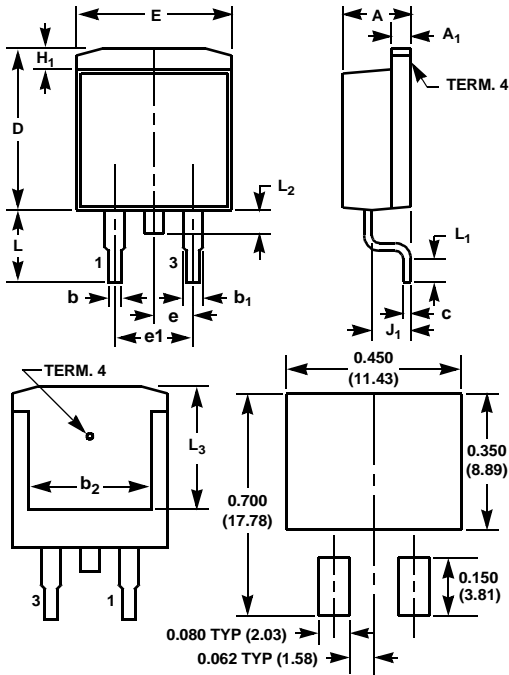
### NOTES:

1. These dimensions are within allowable dimensions of Rev. J of JEDEC TO-220AB outline dated 3-24-87.
2. Lead dimension and finish uncontrolled in L<sub>1</sub>.
3. Lead dimension (without solder).
4. Add typically 0.002 inches (0.05mm) for solder coating.
5. Position of lead to be measured 0.250 inches (6.35mm) from bottom of dimension D.
6. Position of lead to be measured 0.100 inches (2.54mm) from bottom of dimension D.
7. Controlling dimension: Inch.
8. Revision 2 dated 7-97.

FGH30N6S2D / FGP30N6S2D / FGB30N6S2D

**TO-263AB SURFACE MOUNT JEDEC TO-263AB PLASTIC PACKAGE**

**FGH30N6S2D / FGP30N6S2D / FGB30N6S2D**



**MINIMUM PAD SIZE RECOMMENDED FOR SURFACE-MOUNTED APPLICATIONS**

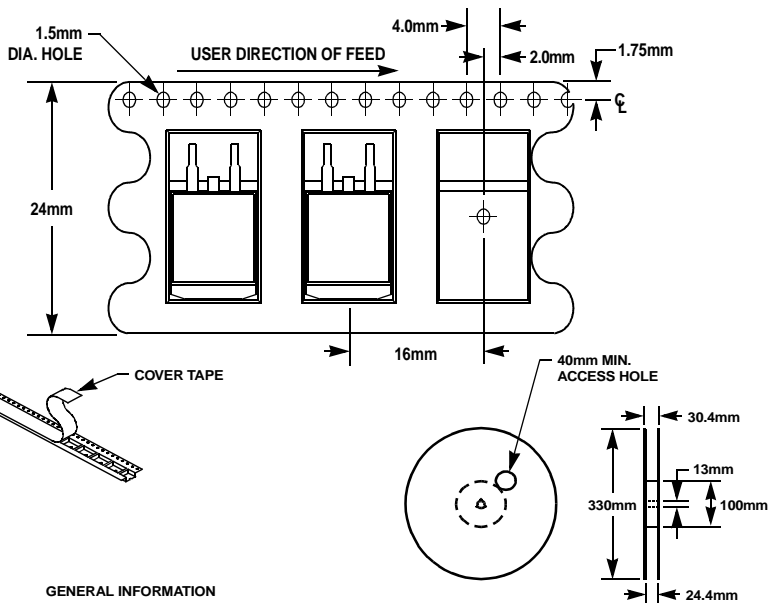
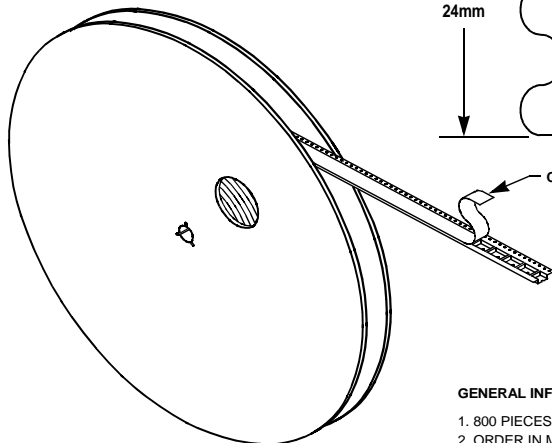
SYMBOL	INCHES		MILLIMETERS		NOTES
	MIN	MAX	MIN	MAX	
A	0.170	0.180	4.32	4.57	-
A <sub>1</sub>	0.048	0.052	1.22	1.32	4, 5
b	0.030	0.034	0.77	0.86	4, 5
b <sub>1</sub>	0.045	0.055	1.15	1.39	4, 5
b <sub>2</sub>	0.310	-	7.88	-	2
c	0.018	0.022	0.46	0.55	4, 5
D	0.405	0.425	10.29	10.79	-
E	0.395	0.405	10.04	10.28	-
e	0.100 TYP		2.54 TYP		7
e <sub>1</sub>	0.200 BSC		5.08 BSC		7
H <sub>1</sub>	0.045	0.055	1.15	1.39	-
J <sub>1</sub>	0.095	0.105	2.42	2.66	-
L	0.175	0.195	4.45	4.95	-
L <sub>1</sub>	0.090	0.110	2.29	2.79	4, 6
L <sub>2</sub>	0.050	0.070	1.27	1.77	3
L <sub>3</sub>	0.315	-	8.01	-	2

**NOTES:**

1. These dimensions are within allowable dimensions of Rev. C of JEDEC TO-263AB outline dated 2-92.
2. L<sub>3</sub> and b<sub>2</sub> dimensions established a minimum mounting surface for terminal 4.
3. Solder finish uncontrolled in this area.
4. Dimension (without solder).
5. Add typically 0.002 inches (0.05mm) for solder plating.
6. L<sub>1</sub> is the terminal length for soldering.
7. Position of lead to be measured 0.120 inches (3.05mm) from bottom of dimension D.
8. Controlling dimension: Inch.
9. Revision 10 dated 5-99.

**TO263AB**

**24mm TAPE AND REEL**



**GENERAL INFORMATION**

1. 800 PIECES PER REEL.
2. ORDER IN MULTIPLES OF FULL REELS ONLY.
3. MEETS EIA-481 REVISION "A" SPECIFICATIONS.

## TRADEMARKS

The following are registered and unregistered trademarks Fairchild Semiconductor owns or is authorized to use and is not intended to be an exhaustive list of all such trademarks.

ACE <sub>x</sub> <sup>TM</sup>	FAST <sup>®</sup>	OPTOPLANAR <sup>TM</sup>	STAR*POWER <sup>TM</sup>
Bottomless <sup>TM</sup>	FAST <sub>r</sub> <sup>TM</sup>	PACMAN <sup>TM</sup>	Stealth <sup>TM</sup>
CoolFET <sup>TM</sup>	FRFET <sup>TM</sup>	POP <sup>TM</sup>	SuperSOT <sup>TM</sup> -3
CROSSVOLT <sup>TM</sup>	GlobalOptoisolator <sup>TM</sup>	Power247 <sup>TM</sup>	SuperSOT <sup>TM</sup> -6
DenseTrench <sup>TM</sup>	GTO <sup>TM</sup>	PowerTrench <sup>®</sup>	SuperSOT <sup>TM</sup> -8
DO <sub>M</sub> E <sup>TM</sup>	HiSeC <sup>TM</sup>	QFET <sup>TM</sup>	SyncFET <sup>TM</sup>
EcoSPARK <sup>TM</sup>	ISOPLANAR <sup>TM</sup>	QS <sup>TM</sup>	TinyLogic <sup>TM</sup>
E <sup>2</sup> CMOS <sup>TM</sup>	LittleFET <sup>TM</sup>	QT Optpelectronics <sup>TM</sup>	TruTranslation <sup>TM</sup>
Ensigna <sup>TM</sup>	MicroFET <sup>TM</sup>	Quiet Series <sup>TM</sup>	UHC <sup>TM</sup>
FACT <sup>TM</sup>	MICROWIRE <sup>TM</sup>	SILENT SWITCHER <sup>®</sup>	UltraFET <sup>®</sup>
FACT Quiet Series <sup>TM</sup>	OPTOLOGIC <sup>TM</sup>	SMART START <sup>TM</sup>	VCX <sup>TM</sup>

STAR\*POWER is used under license

## DISCLAIMER

FAIRCHILD SEMICONDUCTOR RESERVES THE RIGHT TO MAKE CHANGES WITHOUT FURTHER NOTICE TO ANY PRODUCTS HEREIN TO IMPROVE RELIABILITY, FUNCTION OR DESIGN. FAIRCHILD DOES NOT ASSUME ANY LIABILITY ARISING OUT OF THE APPLICATION OR USE OF ANY PRODUCT OR CIRCUIT DESCRIBED HEREIN; NEITHER DOES IT CONVEY ANY LICENSE UNDER ITS PATENT RIGHTS, NOR THE RIGHTS OF OTHERS.

## LIFE SUPPORT POLICY

FAIRCHILD'S PRODUCTS ARE NOT AUTHORIZED FOR USE AS CRITICAL COMPONENTS IN LIFE SUPPORT DEVICES OR SYSTEMS WITHOUT THE EXPRESS WRITTEN APPROVAL OF FAIRCHILD SEMICONDUCTOR CORPORATION.

As used herein:

1. Life support devices or systems are devices or systems which, (a) are intended for surgical implant into the body, or (b) support or sustain life, or (c) whose failure to perform when properly used in accordance with instructions for use provided in the labeling, can be reasonably expected to result in significant injury to the user.
2. A critical component is any component of a life support device or system whose failure to perform can be reasonably expected to cause the failure of the life support device or system, or to affect its safety or effectiveness.

## PRODUCT STATUS DEFINITIONS

### Definition of Terms

Datasheet Identification	Product Status	Definition
Advance Information	Formative or In Design	This datasheet contains the design specifications for product development. Specifications may change in any manner without notice.
Preliminary	First Production	This datasheet contains preliminary data, and supplementary data will be published at a later date. Fairchild Semiconductor reserves the right to make changes at any time without notice in order to improve design.
No Identification Needed	Full Production	This datasheet contains final specifications. Fairchild Semiconductor reserves the right to make changes at any time without notice in order to improve design.
Obsolete	Not In Production	This datasheet contains specifications on a product that has been discontinued by Fairchild semiconductor. The datasheet is printed for reference information only.